

# ANETS

**IMPORTANT FOR FUTURE REFERENCE**

Please complete this information and retain this manual for the life of the equipment:

Model #: \_\_\_\_\_

Serial #: \_\_\_\_\_

Date Purchased: \_\_\_\_\_

## Installation and Operation Manual Covering Model Series SLG40 and SLG100

**AUSTRALIA**



**Gas Safety  
Certified**  
AS 4563  
Cert. GSCS20190  
SAI Global



## FOR YOUR SAFETY

**DO NOT store or use gasoline or other flammable vapors or liquids in the vicinity of this or any other appliance. Do not spray aerosols in the vicinity of this appliance while it is in operation**

## WARNING

**Improper installation, alteration, service or maintenance can cause property damage, injury or death. Read the installation, operating and maintenance instructions thoroughly before installing or servicing this equipment.**

### TO THE PURCHASER

Post, in a prominent location, the instructions to be followed in the event that an operator smells gas. Obtain this information from your local gas supplier.

### WARNING

There is an open flame inside this appliance. The unit may get hot enough to set nearby materials on fire. Keep the area around the appliance free from combustibles.

### WARNING

**DO NOT** supply the appliance with a gas that is not indicated on the data plate. If you need to convert the appliance to another type of fuel, contact your dealer.

### WARNING

**DO NOT** use an open flame to check for gas leaks!

### WARNING

If gas flow to appliance is interrupted, or pilots extinguish, wait 5 minutes before attempting to relight the pilot to allow any residual gas in appliance to dissipate.

### WARNING

Ensure that the appliance can get enough air to keep the flame burning correctly. If the flame is starved for air, it can give off a dangerous carbon monoxide gas. Carbon monoxide is a clear odorless gas that can cause suffocation.

### WARNING

Adequate means must be provided to limit the movement of this appliance without depending on the gas line connection. Single appliances equipped with legs must be stabilized by installing anchor straps. All appliances equipped with

casters must be stabilized by installing restraining chains. If a flexible gas line is used, an additional restraining cable must be connected at all times when the appliance is in use.

### WARNING

An appliance equipped with casters and a flexible gas line must be connected to the gas supply with a quick disconnect device. This quick disconnect must comply with AS4631. To limit the movement of the appliance without depending on the connector or quick disconnect, a restraining cable must also be installed.

### WARNING

Installation of this appliance must be done by a qualified professional. This appliance should be inspected by a qualified professional on an annual basis to insure safe and proper operation.

### WARNING

This appliance must be installed in compliance with AS 5601 (current revision) or local codes, as applicable.

### WARNING

If the appliance has a power supply, it must be disconnected before servicing or cleaning this appliance.

### WARNING

Do not attempt to move this appliance when the unit is at operating temperature. Serious personal injury could result if skin comes in contact with the hot surfaces.

### WARNING

**DO NOT** sit or stand on this appliance. Serious injury could result from falling or contact with hot shortening/oil.

# Table of Contents

<b><u>Section</u></b>	<b><u>Page</u></b>
Installation	
Checking your new Appliance . . . . .	1
<u>Assembly and Leveling</u>	
Leg Installation and Adjustment . . . . .	1
Heat Deflector Installation . . . . .	2
Installation Clearances . . . . .	2
Gas Connection . . . . .	2
Quick Disconnect Gas Connection . . . . .	3
Fuel Supply Line Leak and Pressure Testing . . . . .	3
Ventilation and Fire Safety Systems . . . . .	3
<u>Initial Adjustments</u>	
Burner Ignition Systems . . . . .	4
Lighting Instructions . . . . .	4
Pilot Flame Adjustment . . . . .	5
Main Burner System Adjustment . . . . .	5
Initial Cleaning . . . . .	6
Operation	
<u>Filling the Tank</u>	
Filling the Tank with Liquid Shortening/oil . . . . .	7
Filling the Tank with Solid Shortening/oil . . . . .	7
<u>Operating Instructions</u>	
Appliance Start-Up . . . . .	8
Appliance Shut-Down . . . . .	8
Power Failure . . . . .	8
Maintenance and Adjustments	
<u>Daily Cleaning</u> . . . . .	9
<u>Thermostat Calibration</u>	
Thermostat Calibration Check (Standard) . . . . .	9
Thermostat Calibration (Gas and Electric Thermostat Models) . . . . .	9
<u>Weekly Cleaning</u>	
General Cleaning . . . . .	10
Weekly Boil Out Procedure . . . . .	10
<u>Additional Maintenance and Notices</u>	
Ventilation Hood Maintenance . . . . .	11
Oil Temperature Notice . . . . .	11
Gas Sealant Notice . . . . .	11
Troubleshooting	
<u>Basic Troubleshooting Flow Chart</u> . . . . .	12

# INSTALLATION

## **CHECKING YOUR NEW APPLIANCE**

Your new appliance has been carefully packed into one crate. Every effort has been made to ensure that you it is delivered to you in perfect condition. As you unpack your new appliance, inspect each of the pieces for damage. If something is damaged, DO NOT sign the bill of lading. Contact the shipper immediately; the shipper is only responsible for 15 days after delivery. Check the packing list enclosed with your appliance to ensure that you have received all the parts to the appliance. If you are missing any parts, contact the dealer from whom the appliance was purchased. As you unpack the appliance and its accessories be careful to keep the weight of the appliance evenly distributed.

### **CAUTION**

**To prevent equipment damage and/or personal injury, do not tilt the appliance onto any two of its legs, or pull the appliance by the flue vent.**

## **ASSEMBLY**

When you receive your appliance it is completely assembled with the possible exception of the legs and heat deflector.

### **Leg Installation and Leveling**

This appliance must be installed with legs; it cannot be curb mounted. Curb mounting will seriously inhibit this appliances ability to effect proper combustion.

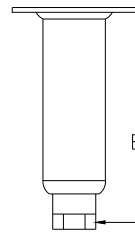

### **WARNING**

**This appliance must be installed with the legs provided by the manufacturer.**

### **WARNING**

**Do not install legs or perform leveling procedure when unit is in operation or full of cooking medium. Serious injury could result.**

Required tools: 7/16 " wrench and socket and a large pair of water pump pliers. The legs must be installed before connecting the appliance to the gas supply. The legs provide the necessary height to meet sanitation requirements and assure adequate air supply to the combustion system. Use the following procedure.

- a. Lay the appliance on its back, being careful not to damage the flue area by pulling on it. Protect the outside of the appliance with cardboard or a drop cloth when laying it down.
- b. Attach each leg with the hex head screws and nuts supplied. Each leg requires four 1/4-20 x 5/8" hex head screws and nuts. Insure that all screws are tight.
- c. Mount the screws from the inside of the appliance with the nut on the outside (bottom) of the appliance. The nuts have lock washers attached to them, therefore it is not necessary to use lock washers
- d. When all four legs are securely mounted, stand the unit up, being careful not to put too much weight on any one leg. Adjust the height and level the appliance by adjusting the leveling devices (B) with water pump pliers.

## Heat Deflector Installation

If the appliance requires a heat deflector, you will find a removable label at the rear top edge of the unit. This label has instructions for positioning and installation of the heat deflector. Refer to the label and the instructions below to install the deflector.

- a. Remove the two self-drilling screws from the top, back area of the appliance.
- b. Position the heat deflector so that the angled portion of the deflector is facing toward the front of appliance. Secure the heat deflector to the back of the unit using the two previously removed fasteners.
- c. When properly installed the angled section of the heat deflector will extend over the flue opening to redirect the heat. It **SHOULD NOT** cover the flue opening. Never allow anything to block the flue opening; this will cause the appliance to over heat and inhibit proper combustion, which could produce dangerous gases

## INSTALLATION

If you have completed the above steps that are applicable to the appliance you purchased, the appliance is now ready to be installed. The appliance must be installed by a qualified professional. A qualified professional will ensure that the installation is safe and meets local building and fire codes and the installation code in force.

### **WARNING**

**DO NOT obstruct the flow of combustion, ventilation or air openings around the appliance. Adequate clearance around the appliance is necessary for servicing and proper burner operation. Ensure that you meet the minimum clearance requirements specified in this manual.**

## Installation Clearances

The clearances shown below are for combustible and non-combustible installations and will allow for safe and proper operation of your appliance.

	Combustible Construction	Non-Combustible Construction
Back	6 in. (15 cm)	6 in. (15 cm)
Sides	6 in. (15 cm)	6 in. (15 cm)
Floor	N/A*	4 ¾ (11.5 cm)

\*For use only on Non Combustible Floors. This appliance must be installed on a fireproof base.

In addition to the above clearances there must also be at least 28 inches (71 cm) of aisle space in front of the appliance.

## Gas Connection

Your appliance will give you peak performance when the gas supply line is of sufficient size to provide the correct gas flow. The gas inlet of the appliance is located in the back of the appliance on the lower right hand side about 21 cm from the floor. The gas line must be installed in accordance with the requirements of AS 5601 or local codes, by a qualified professional. Gas line sizing requirements can be determined by a qualified installation professional, your local gas company or by the Technical Regulator. The gas line needs to be large enough to supply the necessary amount of fuel to all appliances without losing pressure to any appliance. A properly sized and installed gas line will deliver a minimum supply pressure of 7.0 ± 2.0 inches w.c. (1.75 ± 0.5 kPa) for natural gas and 12.0 ± 2.0 inches (3.0 ± 0.5 kPa) for propane to all appliances connected to the supply line, operating simultaneously at full demand. Each appliance is equipped to operate on one certain fuel type. The type of fuel with which the appliance is intended to operate is stamped on the data plate, which is attached to the inside of the door.

# INSTALLATION

## WARNING

**NEVER** supply the appliance with a gas other than the one that is indicated on the data plate. Using the incorrect gas type will cause improper operation and could result in serious injury or death. If you need to convert the appliance to another type of fuel, contact the dealer you purchased it from.

## NOTICE

**NEVER** use an adaptor to make a smaller gas supply line fit the appliance connection. This may not allow proper gas flow for optimum burner operation, resulting in poor performance and improper operation.

## Quick Disconnect Gas Connection

Gas appliances equipped with casters must be installed in compliance with the applicable clauses of The Standard for Gas Installations, AS 5601 (latest edition). This connection should include a quick disconnect device that complies with the Standard for Limited Flexibility Connectors, AS4631 (latest edition). When installing a quick disconnect you must also install adequate means for limiting the movement of the appliance without depending on the connector and quick-disconnect device or its associated piping to limit the movement of the appliance. The restraining device should be attached to the appliance on the back panel.

## Fuel Supply Line Leak and Pressure Testing

The fuel supply system must be tested before the appliance is used. If the fuel line is going to be tested at a pressure greater than ½ PSIG (3.45 kPa), insure that that appliance is disconnected from the fuel line. If the fuel line is to be tested at a pressure equal to or less than ½ PSIG (3.45 kPa), the appliance can be connected during the test, but the unit's gas valve must be shut. Test all gas line connections for leaks with a solution of soap and water when pressure is applied.

## Ventilation and Fire Safety Systems

Your new appliance must have proper ventilation to function safely and properly. Exhaust gas temperatures can reach as high as 1100 °F (593 °C). Therefore, it is very important to install a fire safety system. Your ventilation system should be designed to allow for easy cleaning. Frequent cleaning and proper maintenance of the ventilation system and the appliance will reduce the chances of fire.

It is essential that the appliance be operated only when adequate ventilation is provided. Your ventilation hood should be properly maintained. A qualified installation professional should ensure that the hood is operating properly in conjunction with the appliance. Inadequate ventilation may not properly evacuate appliance all emissions. Excessive or unbalanced ventilation may cause drafts, which could interfere with proper operation of the pilot and burners. Leave at least 18 inches (45.7 cm) of open space between the flue of the appliance and the intake of the exhaust hood.

## CAUTION

**Ensure that your ventilation system does not cause a down draft at the appliance's flue opening. A down draft will not allow the appliance to exhaust properly and will cause overheating, which may cause permanent damage. NEVER** point a fan or similar device at or toward the flue opening of this appliance. Damage caused by down drafts will not be covered by the warranty. **NEVER** allow anything to obstruct the flow of combustibles or ventilation exiting the appliance. **NEVER** place anything on top of the flue area, or block the flue in any way.

## NOTICE

**NEVER** connect the ventilation blower or hood directly to the flue of this appliance. The resulting increased flow of air through the combustion system will cause improper operation, poor temperature recovery, poor ignition and could extinguish the pilot.

## INITIAL ADJUSTMENTS

After your appliance has been properly installed as described in the installation section of this manual, it will need to be adjusted to ensure that it will perform as designed. These adjustments must be performed by a qualified person. To perform these adjustments the following tools will be needed:

- Manometer
- Digital Thermometer (Temperature Probe)
- DC Millivolt Meter
- DC Milliammeter

Before you begin filling and adjusting the appliance, perform the following visual checks:

- a. After the appliance is in its permanent location, check the levelness. Any additional leveling that is necessary can be performed as previously described.
- b. Check the temperature probe and high limit bulb (in the tank) to ensure that the mounting screws are tight.
- c. Review the installation portion of this manual and ensure that all steps have been followed and executed properly.

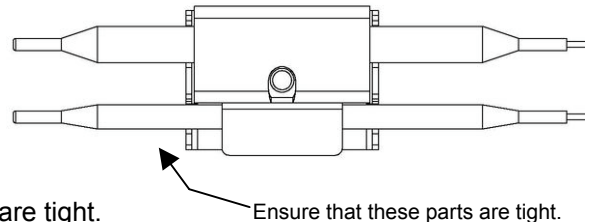

## Burner Ignition Systems

### CAUTION

Before proceeding any further, fill the tank with WATER. Water is used for the installation adjustments because the temperature will never exceed 212°F (100°C), thereby allowing plenty of adjustment time. Never let the water level go below the MIN LEVEL mark stamped on the tank.

### WARNING

During operation there is an open flame inside this appliance. The unit may get hot enough to set near by materials on fire. Keep the area around the appliance free from combustibles.

## Lighting Instructions

For manual pilots, refer to the following instructions.

### WARNING

If pilot extinguishes, wait 5 minutes before attempting to relight the pilot to allow any built up gas to dissipate.

- a. Open gas supply valves to the appliance.
- b. Turn the thermostat control knob counterclockwise to the OFF position.
- c. Turn the gas valve knob to the PILOT position. Push in on the knob while pressing the ignitor button or hold a flame to the pilot until the pilot ignites; this may take a little while the first time you light the pilot because of the air in the lines. Once lit, hold the knob in for approximately one minute and then release.

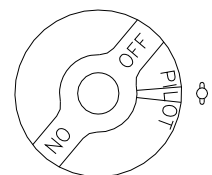

# INSTALLATION

## Lighting Instructions (continued)

- d. If the pilot goes out, wait 5 minutes and repeat step C. If after three tries the pilot will not remain lit, refer to the operator troubleshooting section of this manual.
- e. Once a pilot flame has been established, turn the gas valve knob counterclockwise to the ON position.
- f. Set the thermostat control knob to the desired temperature setting. The main burners will ignite and be controlled by the thermostat.

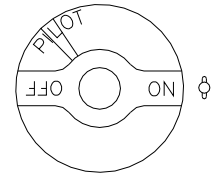

## Pilot Flame Adjustment

For manual pilots, refer to the following instructions. Perform this procedure once the pilot is lit.

NOTE: This procedure requires a DC millivolt meter set to a scale of 0-1000 mV. Using test leads with sharp probes will help in taking the required readings.

- a. Locate the thermopile wires coming from the thermostat/limit box going to the gas valve. The wire size decreases near the gas valve connections.
- b. Using the positive (+) test probe, connect the probe to the high limit wire terminal. On UFM systems, pierce the high limit wire insulation, with the tip of the test lead probe, at the gas valve safety magnet connection.
- c. Connect the negative (-) test probe to the pilot tubing.
- d. Remove the cap screw located below the pilot tubing on the gas valve. The pilot flame adjustment screw is recessed behind this. Turning the pilot flame adjustment screw clockwise lowers the pilot flame and millivolt output. Turning the pilot flame adjustment screw counter-clockwise increases the pilot flame size and millivolt output.
- e. While monitoring the DC millivolt meter, rotate the pilot flame adjustment screw in the direction necessary to achieve a reading of  $400 \pm 50\text{mV}$ .

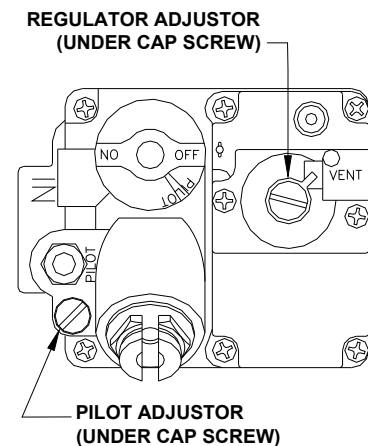

**Note: Allow 3 to 5 minutes between flame adjustments to allow the reading to stabilize.**

- f. Replace the cap screw.

## Main Burner System Adjustment

For the main burners to operate the gas supply valve must be open and the thermostat must be turned on. For models with electric controls, the main power switch must be on. The main burners receive gas from the main gas supply through the thermostatically controlled valve. When the thermostat is turned up to a setting higher than the temperature of the oil in the tank, the gas control valve opens.

The main burner pressure must be adjusted to deliver optimum flame. Refer to the following procedure to adjust the main burners.

## CAUTION

Before proceeding any further, fill the tank with WATER. Water is used for the installation adjustments because the temperature will never exceed 212°F (100°C), thereby allowing plenty of adjustment time. Never let the water level go below the MIN LEVEL mark stamped on the tank.

- a. Ensure that the main gas valve is shut off; remove the manifold pressure tap plug and connect an accurate pressure gauge having a range from 0 to 16 " w.c. in 0.1" increments (0 to 4 kPa in .025 kPa increments) or manometer with similar resolution.

- b. Turn on this and all appliances connected to the gas supply line and light their main burners. The pressure reading of the installed pressure gauge should not drop from the required installation pressure. Any loss of pressure indicates inadequate supply line installation, which will cause poor performance of all appliances during peak usage.

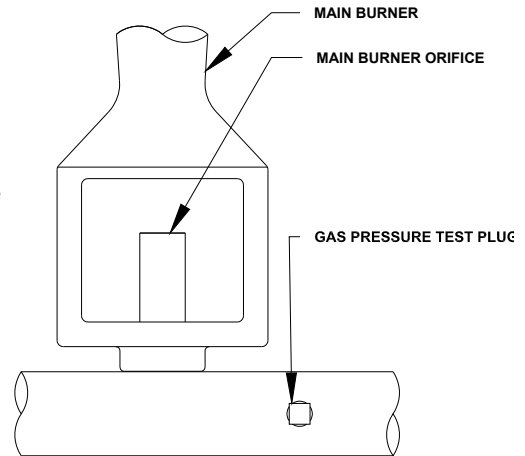

- c. The installed pressure gauge should be the same,  $\pm 0.1$ " w.c. (.025 kPa), as that marked on the data plate on the inside door of the appliance. If the pressure is correct, go to step e, if it is not, adjust the pressure as outlined in step d.

- d. To adjust the pressure, remove the regulator adjustment screw cap on the gas valve and, with a flat head screwdriver, adjust the regulator screw until the proper burner pressure is reached. Turning the screw clockwise will increase the burner pressure. Turning the screw counterclockwise will decrease the burner pressure.

- e. When the pressure is correct, replace the regulator adjustment screw cover.

- f. Turn off the ALL appliances, shut the main gas valve to your appliance and remove the pressure gauge. Apply pipe joint compound to the manifold pressure tap plug and reinstall it.

## Initial Cleaning

When your appliance is shipped, many of its parts are covered with a thin coat of shortening/oil for protection. Before the appliance is ready for cooking it must be cleaned. This will remove the shortening/oil coating and any foreign matter that may have accumulated during storage and shipment. Refer to the following procedure to clean the appliance.

- a. Fill the tank with water. Light the pilot, turn the appliance on and set the thermostat to 200°F (93°C).
- b. Allow the appliance to heat for 15 minutes. Add cleaner to the water, stirring with the cleaning brush to ensure that the cleaner dissolves thoroughly.

## CAUTION

**DO NOT leave the appliance unattended during cleaning. Never let the water level go below the "Min Level" mark stamped on the tank.**

- c. Using the cleaning brush, scrub the inside of the tank to remove the protective coating.
- d. When cleaning is complete turn the appliance off, drain the water into a container suitable for hot water and dispose of it.

## OPERATION

### WARNING

**Wear protective gloves and clothing when cleaning and draining the appliance and when disposing of water. The water is extremely hot and can cause severe injuries.**

- e. When the tank has cooled, rinse thoroughly with cool water. Continue to rinse the tank until the cleaner has been completely and thoroughly rinsed from the tank.
- f. Using a clean dry cloth, wipe out all of the water. Be very thorough when removing the water, as any residual water will cause hot shortening/oil to splatter out of the appliance.

### NOTICE

**Mild steel tanks must be wiped down/coated thoroughly with shortening/oil to keep the tank from rusting**

## FILLING THE TANK

Both liquid and solid shortening/oil can be used in this appliance, but liquid is preferred. If solid shortening/oil is used it is recommended that you melt the shortening/oil before adding it to the appliance. You can melt solid shortening/oil in the appliance, but you must be very careful not to scorch the shortening/oil.

### Filling the tank with liquid shortening/oil

To fill the tank with liquid shortening/oil refer to the following procedure.

- a. Ensure that the drain valve is completely closed and that there is no residual moisture in the tank.
- b. Fill the tank with shortening/oil. You may fill the tank to the "MIN LEVEL" mark or slightly below the nominal level mark: the shortening/oil will expand slightly when it heats up, raising the level slightly.

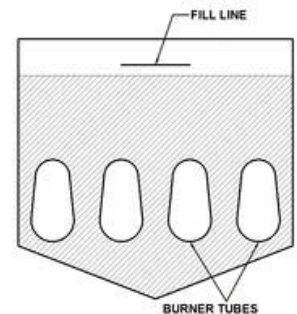

### Filling the tank with solid shortening/oil

To fill the tank with solid shortening/oil refer to the following procedure.

#### WARNING

**NEVER melt blocks of solid shortening/oil on top of the burner tubes. This will cause a fire and could result in personal injury.**

- a. Remove the screen covering the tubes (tube screen).
- b. Cut the solid shortening/oil into cubes no larger than one inch (2.54 cm). ALWAYS pack the shortening/oil below, between, and on top of the burner tubes. **DO NOT** leave any large air gaps. Use care when packing the solid shortening/oil into the tank. **DO NOT** bend or break the temperature or high limit sensor probes. If these are damaged the appliance will not function properly.
- c. Once the appliance tank is firmly packed with shortening/oil, the shortening/oil must be melted. Melt the shortening/oil by cycling the main burners on for 4 seconds and off for 30 seconds repeatedly, using the thermostat knob.

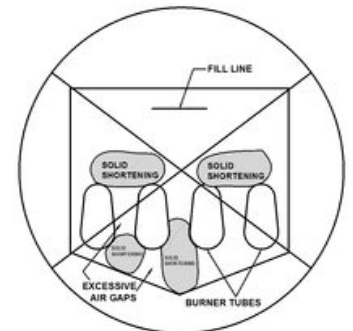
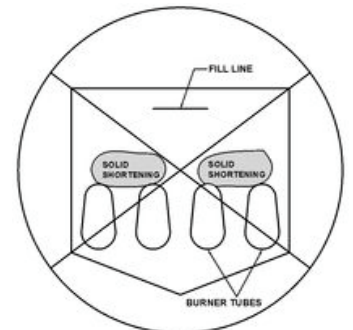

## **OPERATING INSTRUCTIONS**

To ensure the quality of the food you cook in this appliance, follow the preparation instructions from the food manufacturer. Using the best shortening/oil makes the best fried foods. The best shortening/oil will last longer than lower grade shortening/oil and save you money. When not in use, the shortening/oil should be cooled and covered to prevent contamination.

### **WARNING**

**This appliance must be installed using restraining devices to prevent accidental tipping or movement. DO NOT attempt to move the appliance when it is in use or has hot liquid in it. Splashing hot liquids can cause severe burns.**

### **WARNING**

**Water and shortening/oil DO NOT mix. Keep liquids away from hot shortening/oil. Dropping liquid frozen foods into the hot shortening/oil will cause violent boiling.**

## **Appliance Start-Up**

### **WARNING**

**DO NOT start the appliance without filling the tank with shortening/oil first!**

To start up the appliance refer to the following instructions.

- a. Light the pilot as previously described in this manual
- b. Turn the temperature control knob (thermostat) to the desired temperature setting. This knob is located behind the front doors or on the front control panel.
- c. The main burners will light and raise the shortening/oil temperature to the desired setting.

## **Appliance Shutdown**

There are two shutdown modes of appliance operation: STANDBY and COMPLETE. The standby mode removes the ability of the appliances main burners to operate. Complete shutdown turns off the gas supply to the appliance.

**STANDBY** Turn the thermostat to the OFF position. Turn the Pilot knob clockwise to the PILOT position. The cooker is now in Standby and can remain this way for only brief periods of time. NEVER leave the appliance in standby mode for prolonged periods or overnight.

**COMPLETE** Turn the thermostat to the OFF position. Depress and turn the Pilot knob counter clockwise to the OFF position. The appliance is now completely shut down and can be cleaned and filtered if desired.

## **Power Failure**

### **CAUTION**

**DO NOT attempt to operate this appliance during a power outage.**

Wait five minutes after the power is restored before attempting to restart the appliance. This will allow time for any gas that may have accumulated in the burner or tubes to dissipate. To restart the appliance, follow the appliance start up procedure in this manual.

## MAINTENANCE AND ADJUSTMENTS

### **DAILY CLEANING**

Your appliance should be cleaned every day to maintain peak performance, proper sanitation and appearance. Perform the following procedures daily.

- a. Wipe up any shortening/oil that spills onto the exterior of the appliance. This should be done with a clean soft cloth while the shortening/oil is still warm.
- b. Use warm water with a mild detergent to clean surfaces. Be careful not to get water into the shortening/oil and be sure to completely remove any detergent from the fry tank. Use a non-abrasive scouring powder or pad to clean stains if necessary.

#### **NOTICE**

**Maintenance and repairs should be performed by qualified personnel. If you are unsure, contact the factory, factory representative to locate the nearest qualified Service Company.**

### **Thermostat Calibration**

#### **Thermostat Calibration Check (Standard)**

#### **NOTICE**

**Thermostat calibration requires that the temperature of the appliance be raised above boiling. If you have water in the tank you will need to drain it, dry it and fill it with shortening/oil. Follow the filling instructions in this manual.**

To check the calibration of your appliance, refer to the following procedure.

- a. Remove the tube screen from the tank.
- b. Place the tip of a digital thermometer probe in the shortening/oil approximately one inch above the temperature sensor.
- c. Light the pilot as described in this manual, set the thermostat to 325°F (163 °C) and allow the shortening/oil to come up to temperature. Watch the thermometer closely as the temperature rises.
- d. If the shortening/oil temperature reaches 350°F (167 °C) and the burners do not turn off, turn the thermostat down. Keep lowering the thermostat setting until the burners go out.

#### **CAUTION**

**If the burners do not shut off at the LOWEST thermostat setting, the thermostat may be defective. Contact your local service company.**

- e. Let the appliance cycle 4 to 6 times before checking the temperature. Compare the thermometer temperature against the thermostat setting. If the values are more than 5°F (3 °C) apart, calibrate the thermostat using procedure in this manual.

### **Thermostat Calibration**

For Gas Operated and Electric Thermostats refer to the following procedure.

- a. Remove the tube screen from the tank and place the tip of a digital thermometer in the shortening/oil approximately one inch above the temperature sensor.
- b. Light the pilot as described in this manual, set the thermostat to 325°F (163 °C) and allow the shortening/oil to come up to temperature; let the appliance cycle 4-6 times to insure that the shortening/oil temperature has stabilized. Compare the thermostat setting of 325°F (163 °C) to the digital thermometer reading.

## MAINTENANCE AND ADJUSTMENTS

- c. Remove the thermostat dial by pulling the knob straight out. DO NOT rotate the dial.
- d. Holding the outside of the shaft so that it **DOES NOT MOVE**, scrape away the sealing compound in the center of the shaft with a small flat blade screwdriver.
- e. Turn the adjustment screw clockwise to lower the thermostat's temperature setting or counter-clockwise to raise it.

### NOTE

**One-quarter turn of the adjustment screw changes the temperature setting approximately 24°F (13 °C).**

- f. Turn the adjustment screw until the burners come on at 325°F (163 °F).
- g. Replace the knob and allow the appliance to cycle 4 to 6 times. Check the temperature of the digital thermometer against the thermostat dial setting; if there is greater than a 5°F (3 °C) difference, repeat the calibration procedure.

### Weekly Cleaning

The appliance should be thoroughly cleaned AT LEAST once a week. This should include a thorough wipe down of the entire appliance with a rag and mild detergent.

### WARNING

**The power supply must be disconnected before cleaning and servicing this appliance!**

### WARNING

**NEVER spray cleaner into the main burners or pilot. This could act as a magnet for dust and other debris, causing it to accumulate and inhibit the proper operation of your appliance.**

### Boil Out Procedure

The appliance should be boiled out AT LEAST once a week to remove food debris and shortening/oil build up. You will need a container large enough to hold 1 ½ times the shortening/oil in the tank. Refer to the following procedure for weekly boil out.

### WARNING

**Completely shut the appliance down when the shortening/oil is being drained and replaced with water. This will prevent the main burners from coming on during the draining and filling procedure.**

### WARNING

**At operating temperatures, the shortening/oil in the appliance is VERY HOT and can cause severe burns. Do not let the hot shortening/oil touch your skin or clothing. ALWAYS wear insulated, oil proof gloves, protective clothing and eyewear when working on a hot appliance.**

- a. Drain the shortening/oil from the appliance and discard or save for reuse. Remove the tube screen. Close the drain valve and fill the tank with warm water and non-caustic detergent
- b. Restart the appliance as described in this manual and set the thermostat to 200°F (93 °C). Bring the water to a slow boil. DO NOT allow the water to boil excessively as this will cause excessive foaming and boil over.
- c. Allow the appliance to soak for 20 minutes to soften shortening/oil deposits. Use the cleaning brush to scrub and remove any residue from the tank, tubes and side walls.
- d. When finished drain the water and wipe the tank dry with a soft clean cloth.

## MAINTENANCE AND ADJUSTMENTS

- e. Ensure that the drain valve is closed and replace the tube screen.
- f. You may now refill the tank with shortening/oil per the filling instructions in this manual.

### Ventilation Hood Maintenance

Proper ventilation hood operation is very important for the correct operation of this appliance and the safety of personnel. The ventilation hood should be inspected at the time of installation of this appliance to insure that it will operate properly in conjunction with the appliance. A regular schedule of examination and maintenance, to ensure operation in accordance with AS 4566 latest edition and/or applicable local codes, must be followed.

### OIL TEMPERATURE

Keep the oil temperature in the fryer to a maximum of 190°C. Higher temperatures will cause rapid breakdown of the oil and give you no faster cooking. At 205°C to 210°C the life of the oil is only one third of its life at 190°C. In addition, increased decomposition causes the oil to smoke badly even if the temperature is lowered to 190°C again. High oil temperatures give you no advantage, cost you money and increase the fire danger.

### TEMPERATURA DELL'OLIO

Mantenere la temperatura dell'olio nella friggitrice fino a un massimo di 190°C. Temperature maggiori causano un rapido degrado dell'olio, senza tuttavia eseguire una cottura più rapida. Da 205°C a 210°C la durata dell'olio è inferiore di un terzo rispetto a quella a 190°C. Inoltre, l'accresciuta decomposizione comporta una forte emissione di fumo, anche se la temperatura viene riportata di nuovo a 190°C. Le alte temperature non prevedono vantaggi, sono antieconomiche e aumentano il rischio d'incendio.

### ΘΕΡΜΟΚΡΑΣΙΑ ΛΑΔΙΟΥ

Διατηρείτε τη θερμοκρασία λαδιού στη φριτέζα μέχρι 190 βαθμούς Κελσίου. Υψηλότερες θερμοκρασίες θα αλλάξουν τη σύνθεση του λαδιού πολύ σύντομα και δεν ψήνετε γρηγορότερα. Η δυναμικότητα του λαδιού στους 205-210 βαθμούς Κελσίου είναι μόνο το ένα τρίτο (33%) της δυναμικότητάς του στους 190 βαθμούς Κελσίου. Επιπλέον η αυξημένη αποσύνθεση του λαδιού, σε θερμοκρασίες πάνω από 190 βαθμούς Κελσίου, κάνει το λάδι να καπνίζει άσχημα κι αν ακόμη κατεβάσετε τη θερμοκρασία κατόπιν πάλι στους 190 βαθμούς Κελσίου. Οι υψηλές θερμοκρασίες δε σας παρέχουν κανένα πλεονέκτημα, σας κοστίζει περισσότερα χρήματα και αυξάνουν τον κίνδυνο πυρκαγιάς.

### Gas Connection and Sealing Compound

As with any gas appliance, be sure to use a suitable gas joint sealant whenever gas connections are loosened and retightened. Also remember to check for leaks before allowing the appliance to be put into service.

# TROUBLESHOOTING

Refer to this section to correct common problems that may be encountered during the course of normal operation. If applicable, a schematic is provided behind the panel containing the electrical components.

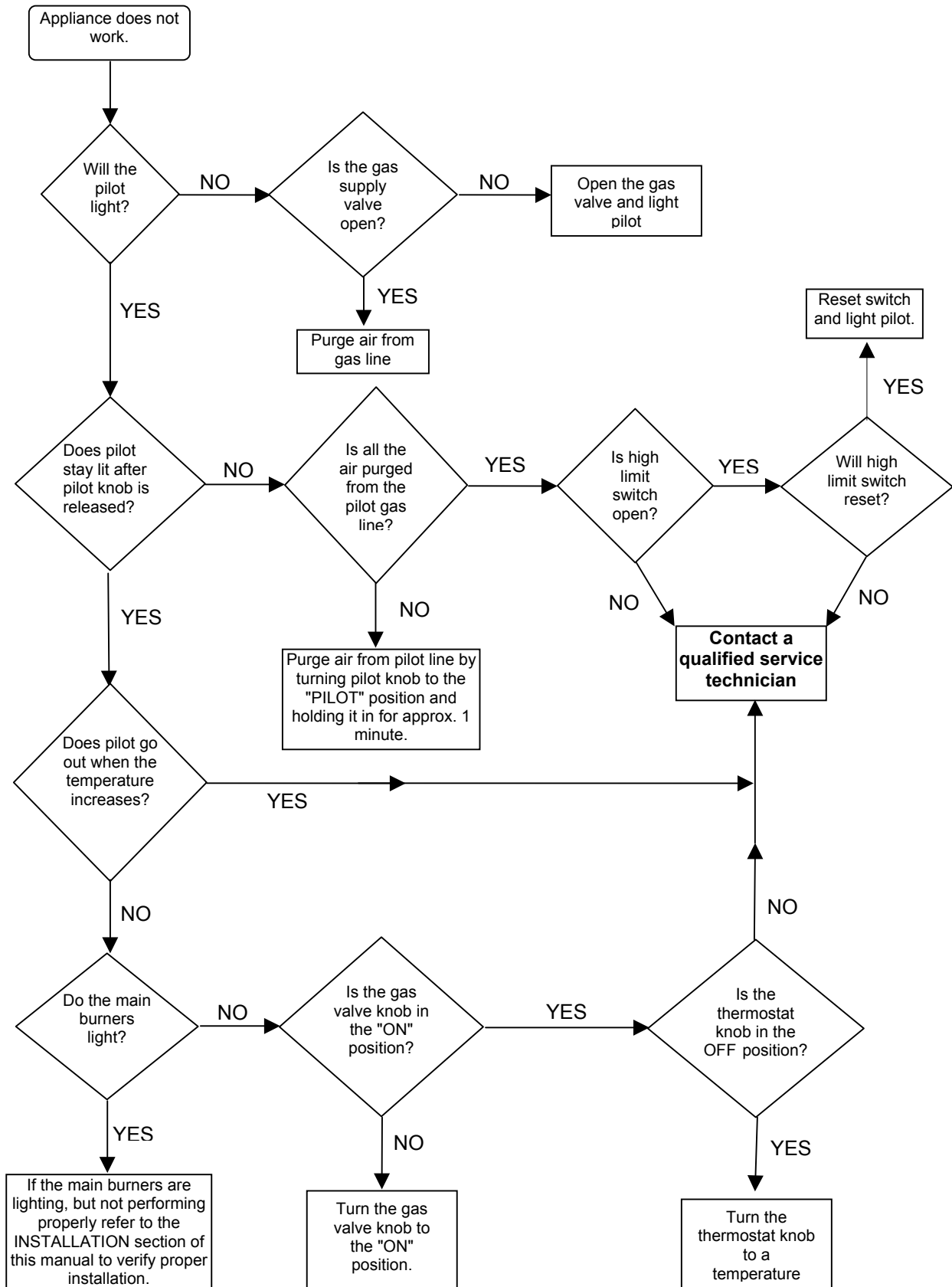

## SLG SERIES OPERATIONAL INFORMATION

Model	SLG40	SLG100
Total Gas Consumption	90 MJ/h	158 MJ/h
Burner Pressure Natural Gas	0.87 kPa	0.87 kPa
Burner Pressure Propane Gas	2.50 kPa	2.50 kPa
Injector Size: Main Burners	2 of	4 of
Natural Gas	3.05 mm (#31)	2.82 mm (#34)
Propane Gas	1.90 mm	1.78 mm (#50)
Injector Size: Pilot	1 of	2 of
Natural Gas	0.56 mm (N22)	1.32 mm (#55)
Propane Gas	0.41 mm (LP16)	0.635 mm (#72)
Minimum Tank Capacity	18.1 kg	31.8 kg
Cooking Area Length	37 mm	46 cm
Cooking Area Width	36 mm	46 cm
Overall Height	121 cm	120 cm
Overall Width	40 cm	50 cm
Overall Depth	70 cm	79 cm
Shipping Weight	66 kg	91 kg

## SLG SERIES PARTS LIST

Model	Component	Part Number	
		Natural Gas	LP
<b>SLG40</b>	Gas Valve	PP11001	PP11002
	Thermocouple	P5047540	
	Thermostat	P5047590	
	Thermostat Knob	PP10539	
	High Limit Switch	PP10084	
	Bulb Clamp	A1408002	
	Pilot	A8047001	A8047002
	Pilot Orifice	P6071666	P6071665
	Ignitor	P9131-55	
	Ignitor Control	P9132-34	
	Main Burner	E4556-04	
	Main Burner Orifice	P8905-04	A8047103
	Burner Support Bar	B13790-00	
	Wing Nut	4003-0295900	
	Tube Rack	P9800-45	
	Basket	P9800-08	
	Basket Hanger	P9054-01	
	Drain Valve	60084502	
Drain Extension	P9313-60		

Model	Component	Part Number	
		Natural Gas	LP
<b>SLG100</b>	Gas Valve	PP10955	PP10956
	Thermocouple	P5047540	
	Thermostat	P5047590	
	Thermostat Knob	PP10539	
	High Limit Switch	PP10084	
	Bulb Clamp	A1408002	
	Pilot Burner Tube	P8903-19	P8903-18
	Pilot Orifice	P9131-62	P8904-99
	Ignitor	P9131-55	
	Ignitor Control	P9132-34	
	Main Burner	E4556-04	
	Main Burner Orifice	P8905-83	A8047102
	Burner Support Bar	B14052-00	
	Wing Nut	4003-0295900	
	Tube Rack	P9800-42	
	Basket	P9800-48	
	Basket Hanger	C9183-00	
	Drain Valve	60084502	
Drain Extension	P9313-60		

In the event of problems with or questions about your order, please contact the Anetsberger Factory at:  
+001 (603) 225-6684 (World Wide)

In the event of problems with or questions about your equipment, please contact the Anetsberger Authorized Service and Parts representative (ASAP) covering your area, or contact Anetsberger at the number listed to the left.

**MAILING ADDRESS – P.O. BOX 501, CONCORD, NH 03302-0501**  
**SHIPPING ADDRESS – 10 FERRY ST., CONCORD, NH 03301**